

AHŞAP KİRİŞLİ KALIP SİSTEMİ

WOODEN BEAM WALL FORMWORK SYSTEM

■ H20 AHŞAP KRŞ (H20 WOODEN BEAM)

ÖLÇÜ (CM)	AĞIRLIK (KG)
245	12,30
265	13,30
290	14,50
330	16,50
360	18,00
390	19,50
450	22,50
490	24,50
590	29,50

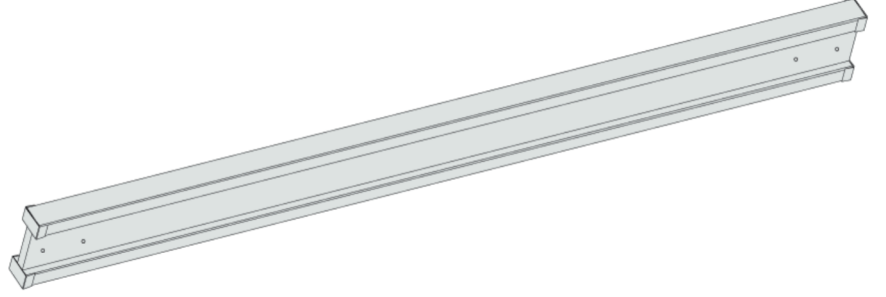

■ ÇELİK PERDE KUŞAĞI (STEEL WALER)

ÖLÇÜ (CM)	AĞIRLIK (KG)
95	20,90
120	26,40
145	31,90
195	42,90
220	48,40
245	53,90
295	64,90

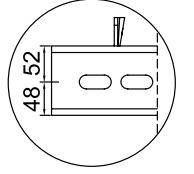
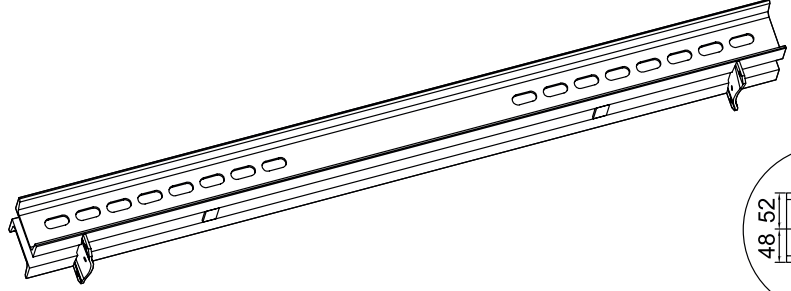

■ KÖŞE KUŞAĞI (CORNER WALER)

ÖLÇÜ (CM)	AĞIRLIK (KG)
50*50	17,60
50*75	23,10
75*75	28,60
75*100	34,10

KÖŞE ÖLÇÜSÜ (CORNER SIZE)

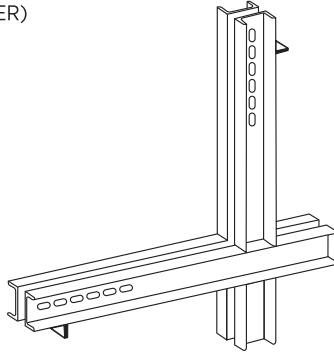

■ KOLON KUŞAĞI (COLUMN WALER)

ÖLÇÜ (CM)	AĞIRLIK (KG)
50*50	41,80
60*60	46,20
70*70	50,60
80*80	55,00
90*90	59,40
100*100	63,80

KOLON ÖLÇÜSÜ (COLUMN SIZE)

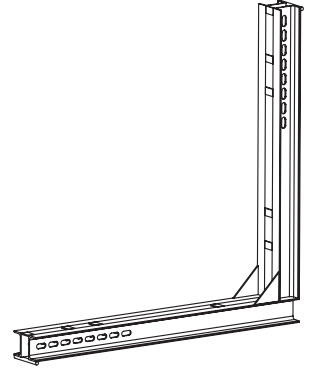

■ KUŞAK BİRLEŞTİRME ELEMANI (WALER COUPLER)

ÖLÇÜ (CM)	AĞIRLIK (KG)
99	9,70
149	13,50

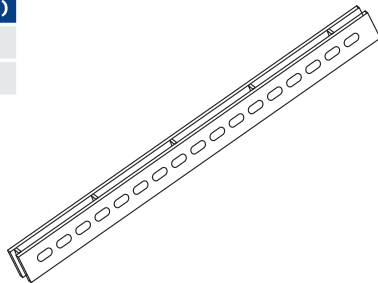

■ MAFSALLI KUŞAK BİRLEŞTİRME (ARTICULATED WALER COUPLER)

ÖLÇÜ (CM)	AĞIRLIK (KG)
120	11,00

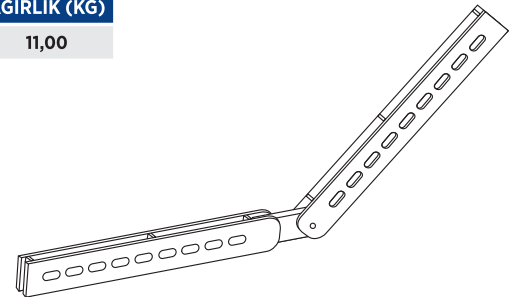

AHŞAP KİRİŞLİ KALIP SİSTEMİ

WOODEN BEAM WALL FORMWORK SYSTEM



ALIN BAĞLAMA PLAKASI (END PLATE)

AĞIRLIK (KG)
3,20

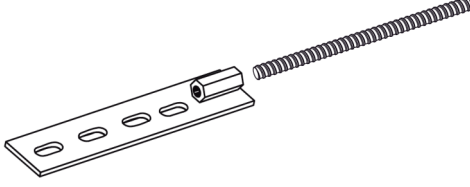

Alın panoları için üretilmiştir. Kumaş kaması ile kullanılır.
For stopend panels, Used with waler wedges.

KÖŞE BİRLEŞTİRME ELEMANI (CONNER CONNECTOR)

AĞIRLIK (KG)
2,60

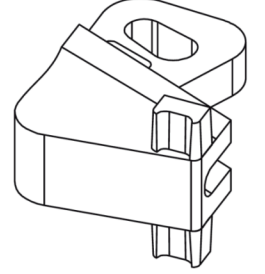

H20 KLİPS (H20 CLIPS)

AĞIRLIK (KG)
0,60

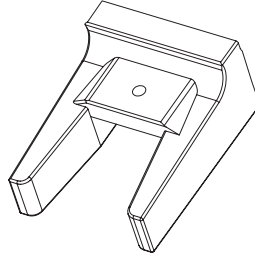

KUŞAK KAMASI (WALER WEDGE)

AĞIRLIK (KG)
0,90

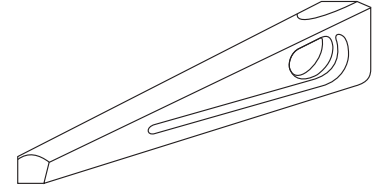

H20 BAĞLAMA KANCASI (H20 HOOK SET)

AĞIRLIK (KG)
0,90

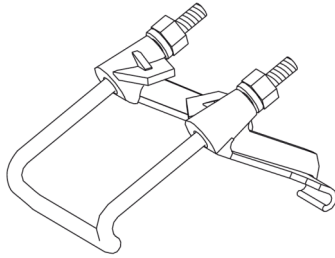

Ahşap kirişlerin çelik kuşaklara bağlantısını sağlar.
For connecting wooden beams to steel walers.

H20-H20 EKLEME ELEMANI (H20-H20 EKSTENSON)

AĞIRLIK (KG)
7,00



KİRİŞ BAĞLANTI TAKIMI (COUPLING COMPRESSION COMPONENT)

AĞIRLIK (KG)
1,20

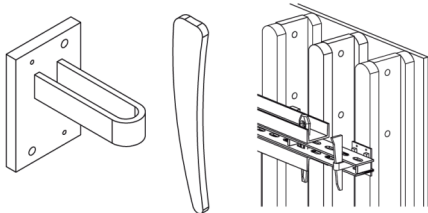

Dolgularda ahşap kirişlerin kuşak birleştirme elemanlarına bağlantısını sağlar.
Bir adet aksesuar kaması gerekir.
For connecting wooden beams to waler couples with one wedge to form infills.

VİNÇ KULPU TAKIMI (CRANE SPLICE)

AĞIRLIK (KG)
4,50

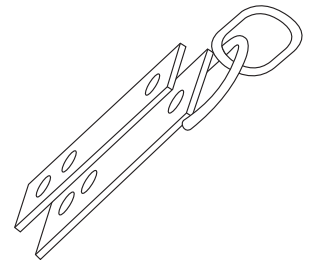

2 Adet M 16x60 Civata ve Somun Dahil

Taşıma kapasitesi 500 kg. Her panel için en az 2 adet olmalıdır.

AHŞAP KİRİŞLİ KALIP SİSTEMİ

WOODEN BEAM WALL FORMWORK SYSTEM



■ PAYANDA Q60 - Q76 (PUSH PULL PROPS Q60 - Q76)

BORU ÇAP (MM)	ÖLÇÜ (CM)	AĞIRLIK (KG)
60	100	12,00
60	120	12,50
60	150	15,00
60	175	16,00
60	200	16,50
60	250	19,60
60	300	23,00
76	400	49,10
76	600	66,70

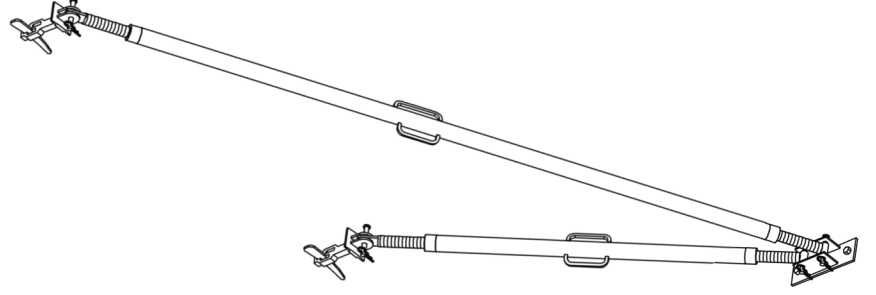

■ ANKRAJ MİLİ (TIE ROD MILI Ø 15/17)

ÖLÇÜ (CM)	AĞIRLIK (KG)
100	1,50
120	1,80
150	2,20
200	3,00

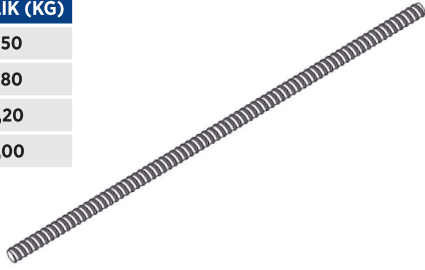

■ PAYANDA KAFASI (PUSH PULL PROD HEAD)

AĞIRLIK (KG)
2,10

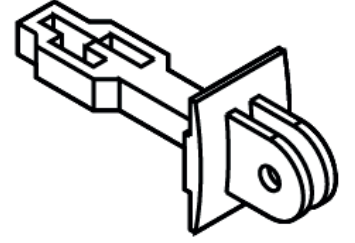

■ TİE ROD SOMUNU (WALER WING NUT)

AĞIRLIK (KG)
0,5

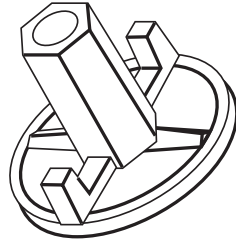

■ PAYANDA KAMASI (APUSH PULL PROD WEDGE)

AĞIRLIK (KG)
0,5



■ AYNA (PLATE)

AĞIRLIK (KG)
0,9

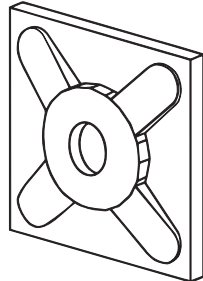

■ PAYANDA TABANI (BASE PLATE)

AĞIRLIK (KG)
2,0

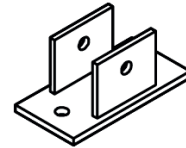

TEKLİ PAYANDA TABANI
(BASE PLATE)

ÇİFTLİ PAYANDA TABANI
(DOUBLE BASE PLATE)

AĞIRLIK (KG)
3,0

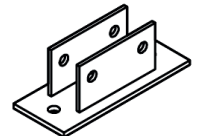

AHŞAP KİRİŞLİ KALIP SİSTEMİ

WOODEN BEAM WALL FORMWORK SYSTEM



ÇALIŞMA KONSOLU (BRACKET)

AĞIRLIK (KG)

7,00

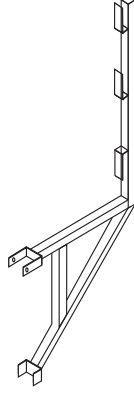

CİVATA VE SOMUN (BOLT AND NUT)

ÖLÇÜ (MM) AĞIRLIK (KG)

16*60 0,10

16*100 0,15

16*120 0,20

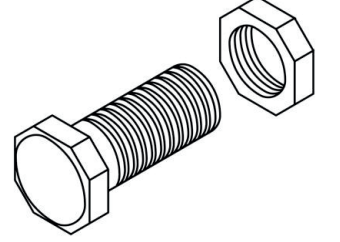

PİM KOPİLYA (PIN AND SPLIT PIN)

ÖLÇÜ (MM) AĞIRLIK (KG)

16-80 0,15

20-130 0,25

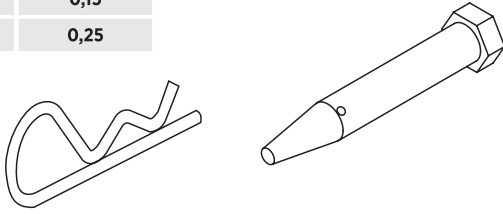

AHŞAP VİDASI (WOOD SCREW)

ÖLÇÜ (MM) AĞIRLIK (KG)

6*60 0,01

